

Project Name: _____ AIA#: _____

Model #: _____ Location: _____

SIS#: _____ Item #: _____ Quantity: _____



Chefmate® by Globe Medium Duty Manual Slicer

**Safe and easy to use and
clean, plus easy on the budget!**

*Gear driven knife, stain resistant
anodized aluminum with removable parts.*



Model

- GC512 – 12" Diameter Knife

Standard Features

- 12" diameter gear driven, high torque knife
- 7/8" slice thickness
- 1/3 HP totally enclosed knife motor, permanently lubricated sealed ball bearings
- Stain resistant and easy to clean anodized aluminum base
- Easy to access top mounted, removable metal knife sharpener, with two stones and dual action for a razor sharp cutting edge!
- Knife cover interlock and permanently attached knife ring guard - for added operator safety during use and cleaning
- Stainless steel knife, food chute and slicer table
- Stainless steel knife and motor covers, slice deflector, and product receiving tray
- Easy-to-clean removable slice deflector and product tray
- Moisture proof, sanitation sealed ON/OFF switch
- Includes 6 foot cord and plug
- Power indicator light
- Non-slip rubber feet

Warranty

- One-year parts and labor

Optional items

- Vegetable hopper
- Slicer cover
- Extended warranty

To select options, see complete list on back



AutoQuotes

Approved by: _____ Date: _____

2153 Dryden Rd., Dayton, OH 45439 | 937-299-5493 | 800-347-5423 | Fax: 937-299-4147 | www.globefoodequip.com

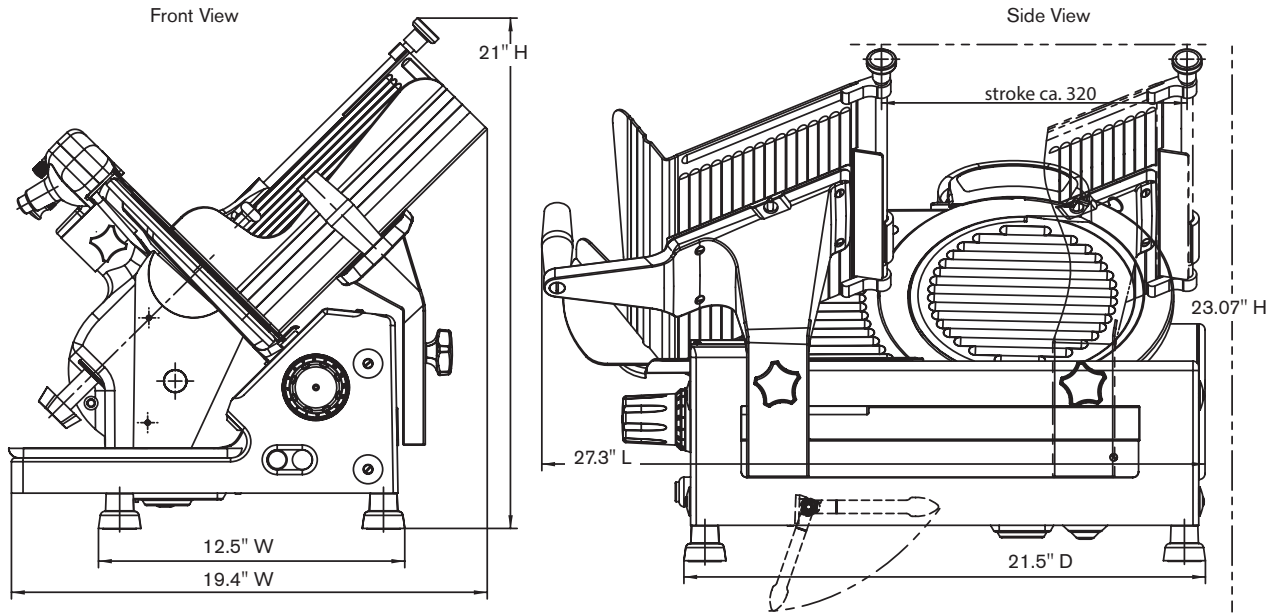

SPECIFICATIONS												
Model	Auto or Manual	Motor	Volts	Amps	Drive Type	Slicing Volume per Day	Cheese Slicing	Blade Diameter	Max Slice	Product Cutting Capacity		
										W (Width)	D (Diameter)	H (Height)
GC512	Manual	1/3 HP	115-60-1	4.8	Gear	4 hours		12" (30.5 cm)	7/8" (1.4 cm)	10" (25.4 cm)	7.5" (19.5 cm)	8.75" (22.2 cm)

Cord & Plug: Attached 6 foot flexible 3-wire cord with molded plug fits a grounded receptacle. NEMA 5-15

DIMENSIONS SHIPPING INFORMATION				
Reinforced carton for shipping. The weight and dimensions of this reinforced carton are included below and may vary from shipment to shipment. Freight class 77.5				
Model	Overall Dimensions	Net Wt	Shipping Dimensions	Shipping Wt
GC512	19.4" w x 27.3" d x 21" h (49 cm x 69 cm x 53 cm)	88 lbs (40 kg)	21.5" w x 26.5" d x 28" h (55 cm x 67 cm x 71 cm)	110 lbs (50 kg)

Slicer has 12" diameter knife with anodized aluminum base and stainless steel food chute, slicer table, knife, knife and motor covers and product tray. Unit has 1/3 HP motor with permanently lubricated ball bearings. Slicer has top mounted, removable, dual action knife sharpener with two stones, and removable slice deflector and product tray. On/Off switch and electric wiring are moisture proof, with sealed splash zones. Slicer is NSF and ETL listed. One year parts and labor warranty.

OPTIONAL ITEMS:

- A420VH** vegetable hopper
- SC-LARGE** large slicer cover
- G-XDSL** Extended warranty extends factory warranty to 2 years on parts and labor in the continental U.S.

Available only at time of purchase.